

# Instruction Manual

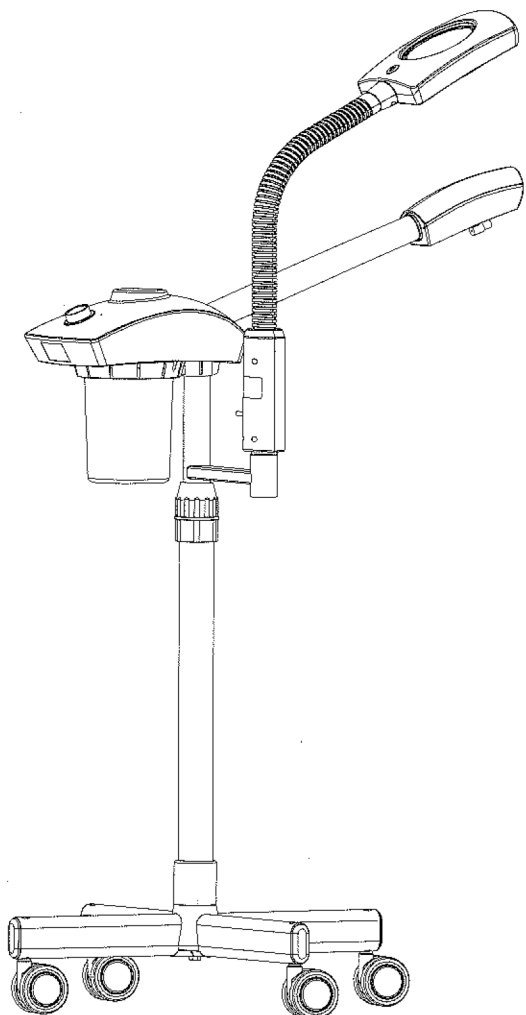

## 2-IN-1 BEAUTY INSTRUMENT (Facial Steamer + LED Mag Lamp )





Designed by and for Professionals

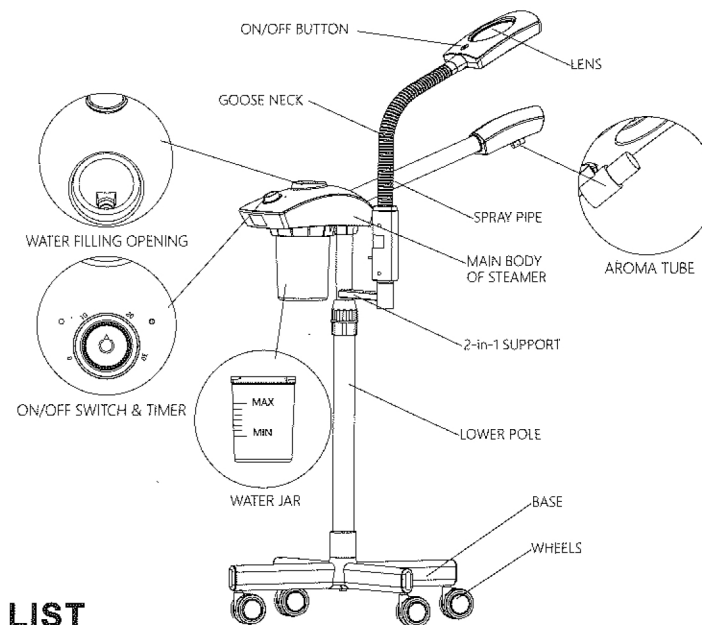

### COMPONENT NAMES

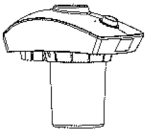
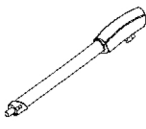
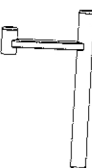

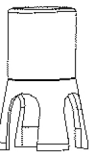
### PART LIST

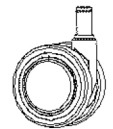
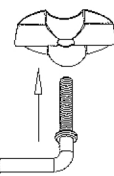
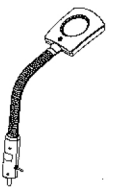
A: MAIN BODY OF STEAMER	B: SPRAY PIPE	C: 2-in-1 SUPPORT	D: LOWER POLE	E: HUB
1PCS	1PCS	1PCS	1PCS	1PCS
				
F: LEG	G: WHEEL	H: WASHER & BOLT	I: LED Mag Lamp	J:
2PCS	4PCS	1PCS	1PCS	
				



## INSTALLATION

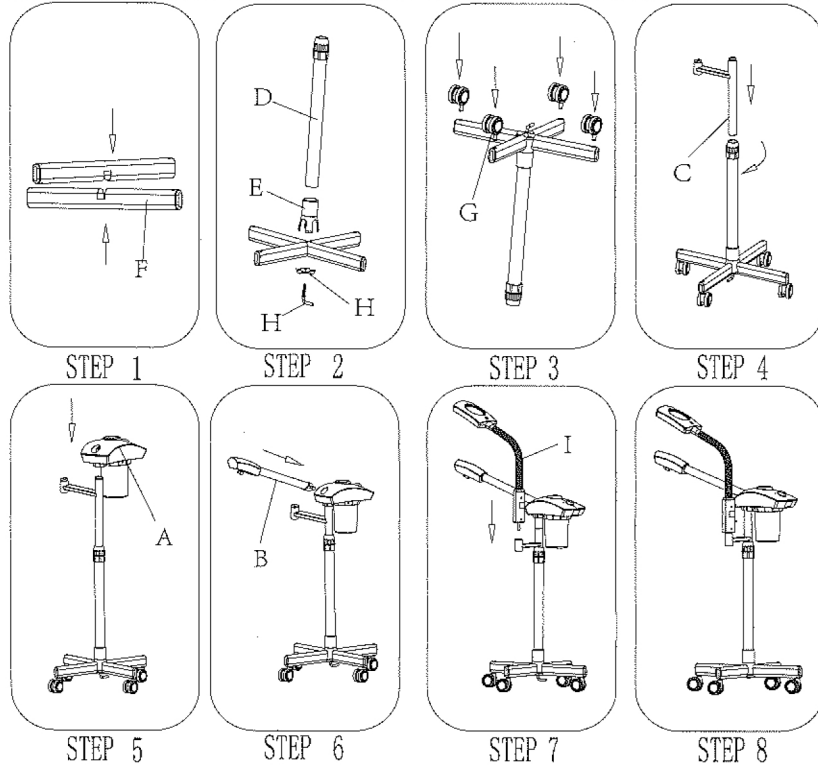

## WARNING

1. An appliance should never be left unattended when plugged in.
2. Close supervision is necessary when this appliance is used by, on, or near children or individuals with certain disabilities.
3. Use this appliance only for its intended use as described in this manual. Do not use attachments not recommended by the manufacturer.
4. Never operate this appliance if it has a damaged cord or plug, if it is not working properly, or if it has been dropped, damaged, or dropped into water. Return the appliance to a service center for examination and repair.
5. Keep the cord away from heated surfaces. Do not wrap the cord around the appliance.
6. Never block the air openings of the appliance or place it on a soft surface, such as a bed or couch, where the air openings may be blocked. Keep the air openings free of lint, hair etc.
7. Never use while sleeping.
8. Never drop or insert any object into any opening or hose.
9. Do not use in the outdoors or operate where aerosol (spray) products are being used or where oxygen is being administered.
10. Unplug this appliance before filling. Fill (reservoir) with water only. Do not overfill.
11. Do not use an extension cord with this appliance.
12. Use facial steamer only on a level surface.
13. Do not use additives.
14. Never hold this facial steamer close to your face in one position as this may cause scalding.

Do NOT expose naked eyes directly to the led lights, doing so may cause discomfort or damages to eyes

## OPERATIONS(Facial Steamer)

1. Check and make sure the water jar is on securely and aligned.

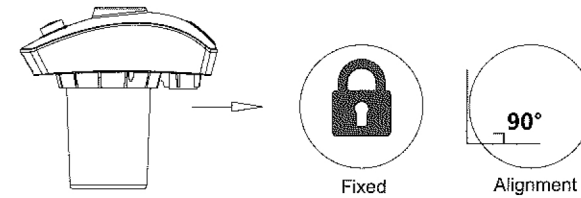

Observe for alignment before use

2. Fill the water jar through the top opening with clean water. Make sure the water level is between the MAX and MIN marks.

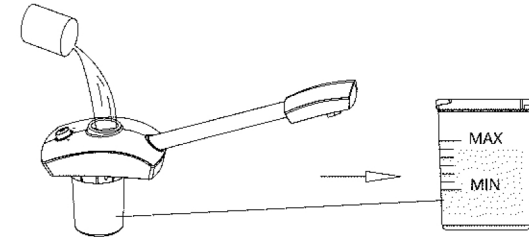

3. Turn the timer knob to set your desired operation time (from 0 minute to 30 minutes)

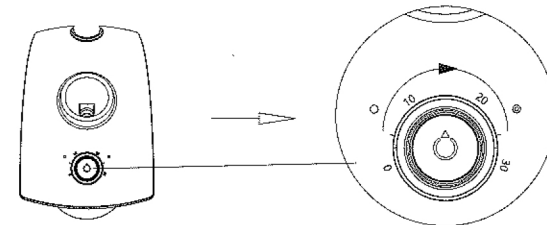

4. Press the ON/OFF button to turn on the unit. The unit will start to heat the water and the UV light will illuminate at the same time. The steam will start to spray in about 5 minutes when the water boils. ( The time may vary depending on volume and temperature of water)

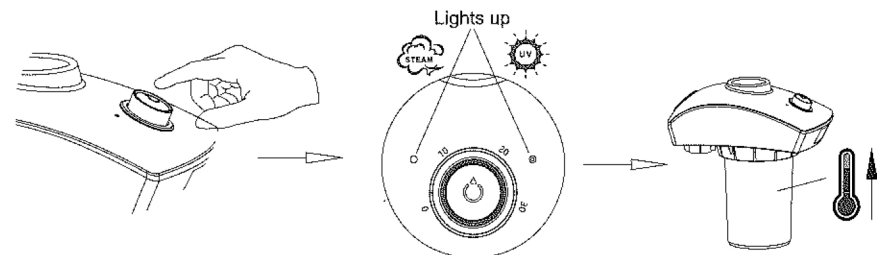

5. The UV light can be controlled individually. Press the ON/OFF button and hold for 5 seconds, the UV light will turn on or turn off

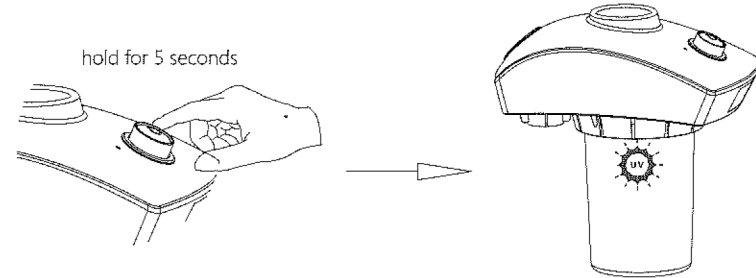

6. When the steam comes out from the spray pipe, get it close to the client's face. The ideal distance between the spray nozzle and the client's face is about 20cm. Don't get too close to the client's skin to avoid burning.

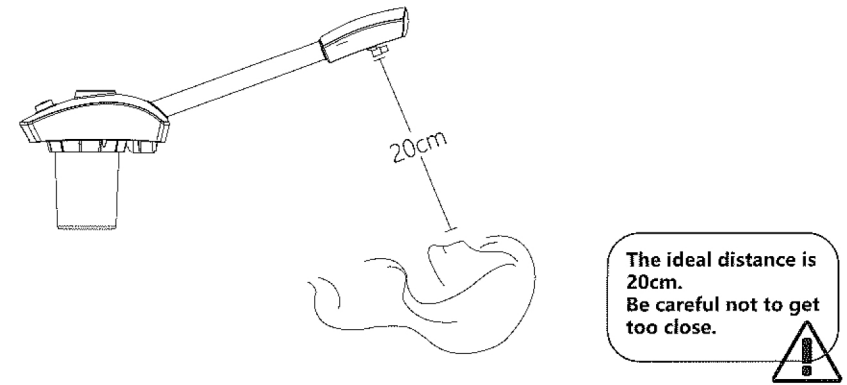

7. Aroma therapy function: Put a piece of cotton into the aroma tube, and drop some essential oils on the cotton. The aroma will be brought out when the steam sprays

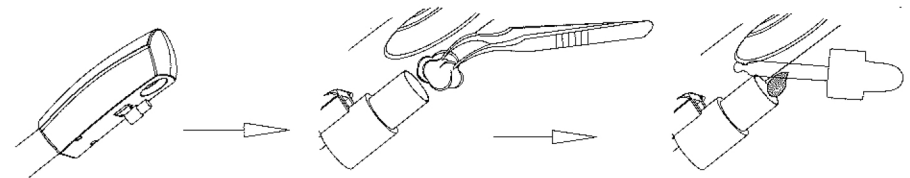

## OPERATIONS(LED Mag Lamp )

1. Check and make sure the unit is securely installed
2. Plug in and connect to 110V-240V power

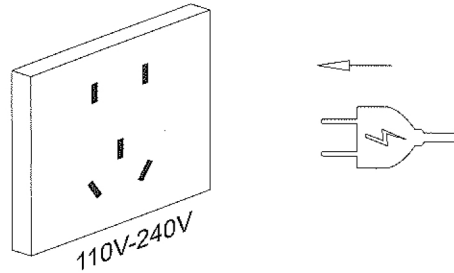

3. Press the ON/OFF button and the LED lamp will illuminate.

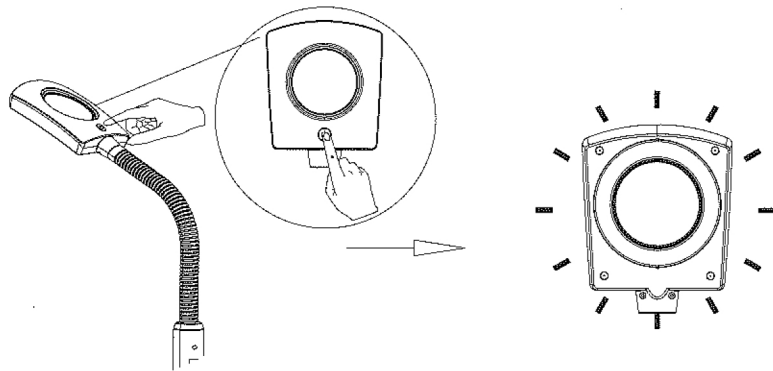

4. Press the ON/OFF button again to adjust brightness

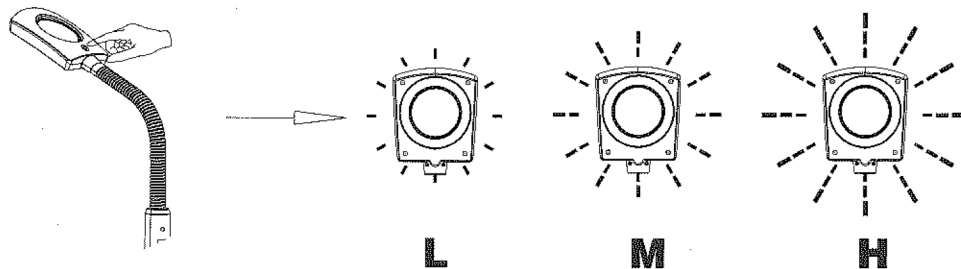

5. Adjust the gooseneck to your desired angle

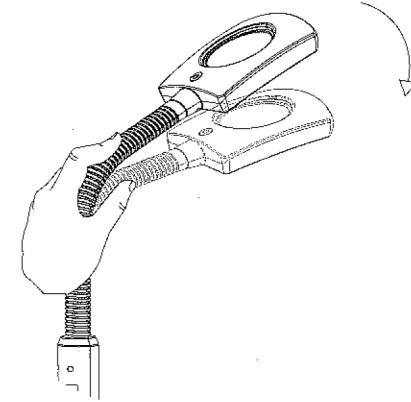

6. To switch off the LED lamp, press the ON/OFF button and hold for 2 seconds

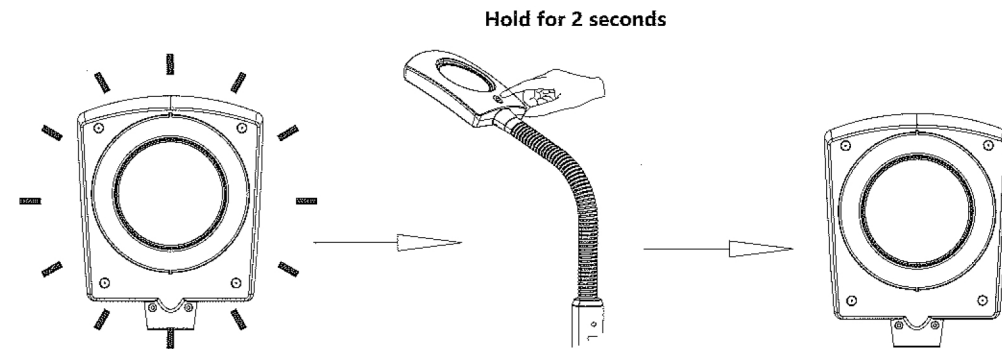

## MAINTAINING(LED Mag Lamp )

1. Unplug the unit before maintaining
2. Clean the glass lens with a soft alcohol wipe, or soft fabric with mild detergents

DO NOT use coarse fabrics to clean the glass lense. doing so many scratch the lens and reduce the transparency



## MAINTAINING(Facial Steamer)

Clean the water jar every 1 or 2 months depending on frequency of usage.

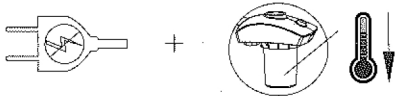
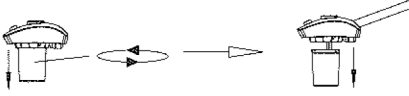
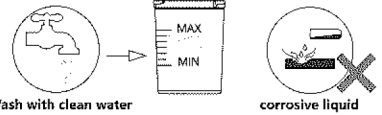
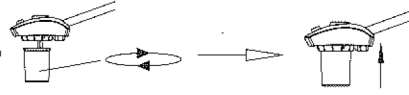
<p><b>Step 1:</b> Unplug the unit and make sure the water jar is NOT HOT.</p>	<p><b>Step 2:</b> Remove the water jar from the main body by turning it anti-clock wise.</p>
	
<p><b>Step 3:</b> Wash the water jar with clean water. DO NOT use corrosive detergents.</p>	<p><b>Step 4:</b> Install the water jar to the main body by turning it clock wise.</p>
	

If the heating pipe is incrustated, clean it with 5% vinegar solution

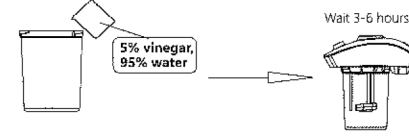
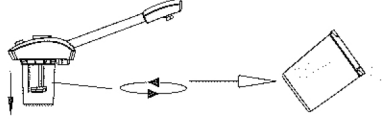
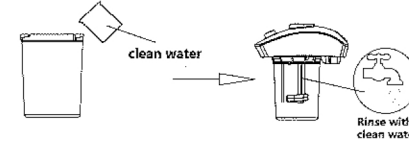
<p><b>Step 1:</b> Unplug the unit and make sure the water jar is NOT HOT.</p>	<p><b>Step 2:</b> Immerse the heating pipe into 5% vinegar solution(5% vinegar, 95% water) and let it stay for 3-6 hours, the incrustant will come off gradually</p>
	
<p><b>Step 3:</b> Remove the water jar from main body by turning it anti-clock wise and pour out the vinegar solution.</p>	<p><b>Step 4:</b> Rinse the heating pipe in the water jar with clean water</p>
	

## THERMO-CONTROL SYSTEM

This facial steamer comes with a thermo-control system for safety purposes. When the unit is over-heated due to lack of water, the unit will shut off automatically, and the indicator lights for steam and UV will start to blink. To turn on the steamer again, please fill the water tank with clean water and wait for the unit to cool down for a while. When the indicator lights for steam and UV stop blinking and turn off, press the ON/OFF button and the unit will start working again.

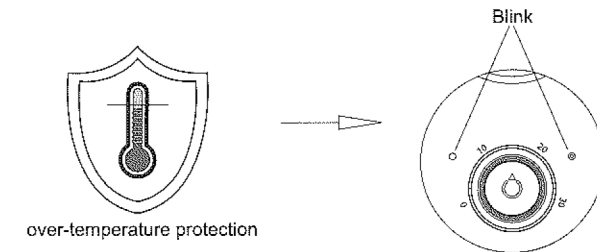

## TYPES OF WATER TO BE USED

This facial steamer works with almost all types of clean water, such as purified water, distilled water, mineral water, tap water and etc. However, for the best performance and proper maintaining of this unit, please use purified water or distilled water. **WARNING:** Please do not add any additives or essential oils into the water. Doing so may damage the unit or cause injure to users.

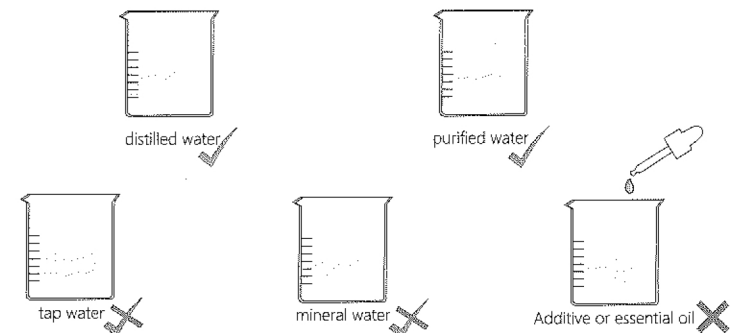

## Note the following Cautions

1. Do not place the device upside down or tilt it when it is in operation; use it only on a level surface.
2. Do not start the device without water.
3. Do not use additives in the water
4. Clean the water tank frequently. Make sure to turn off the power and unplug before taking off the water tank and allow time for the unit to completely cool.
5. Do not touch the water tank when it is hot.
6. Make sure to drain the water if the device is left not in use for a long time.
7. This device has been thoroughly tested and examined. In case of any malfunction, please contact your local distributors. Non-authorized repair or tampering will invalidate the warranty. When using electrical appliances, especially when children are present, basic safety precautions should always be followed.